

TZN/TZ Series

Dual PID auto tuning controller

■ Features

- Dual PID auto tuning function
 - : There are high-speed response and low speed response mode in dual PID function. When you need to reach to the desired value fast, high speed(PIDF Mode) should be used and when you need to minimize the overshoot even though response is a little bit slower, low speed response should be used.
- High display accuracy
 - : High accuracy : $\pm 0.3\%$ (by F · S value of each input)
- 2-step auto tuning control function
- Multi-input function
 - : 13 kinds of multi-input selection function such as temperature sensor, voltage and current selection function.
- Various sub output function
 - : LBA, SBA, 7kinds of alarm output, and 4 kinds of alarm option function
 - Built in PV value transmission output(4-20mADC), RS485 communicate output
- Display the decimal for analog input



⚠ Please read "Caution for your safety" in operation manual before using.



■ Ordering information

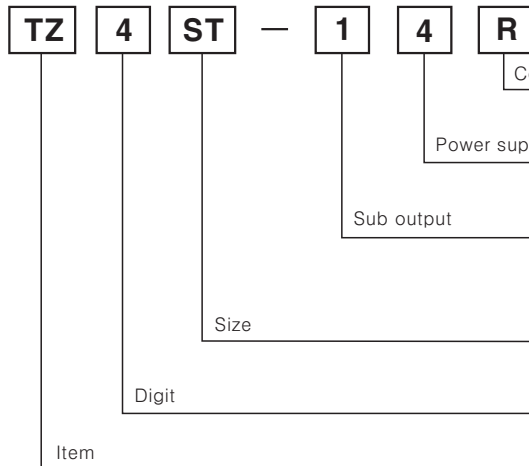

※ Blacked items are upgraded function.

R	Relay output
S	SSR output
C	Current output(4-20mADC)
4	100-240VAC 50/60Hz
1	Event 1 output
2	Event 1 + Event 2 output (※1)
R	Event 1 + Transmission output(4-20mADC) (※2)
S	DIN W48×H48mm (Terminal type)
SP	DIN W48×H48mm (Plug type)
ST	DIN W48×H48mm (Terminal type)
4	4 Digit
TZ	Temperature PID
TZN	Temperature PID New Type

(※1) Only for TZN4S Type (※2) Only for TZ4ST Type

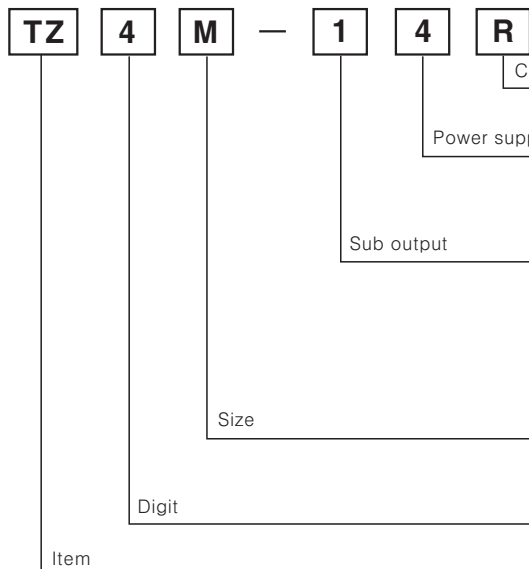

R	Relay output
S	SSR output
C	Current output(4-20mADC)
4	100-240VAC 50/60Hz
1	Event 1 output
2	Event 1 + Event 2 output
R	Event 1 + Transmission output(PV 4-20mADC)
A	Event 1 + Event 2 + Transmission output(PV 4-20mADC)
B	Event 1 + Event 2 + RS485
T	Event 1 + RS485
M	DIN W72×H72mm
W	DIN W96×H48mm
H	DIN W48×H96mm
L	DIN W96×H96mm
4	4 Digit
TZ	Temperature PID
TZN	Temperature PID New Type

※ All models have EV-1 output.
 ※ TZN4W and TZN4L types are coming soon.

Dual PID Auto Tuning Controller

■ Specifications

Series	TZN4S	TZN4M	TZN4H	TZ4SP	TZ4ST	TZ4M	TZ4H	TZ4W	TZ4L
Power supply	100-240VAC 50/60Hz								
Allowable voltage range	90~110% of power supply								
Power consumption	5VA	6VA	5VA			6VA			
Display method	7Segment LED Display 【Processing value (PV) : Red, Setting value (SV) : Green】								
Character size	PV W7.8×H11mm SV W5.8×H8mm	PV W8×H13mm SV W5×H9mm	PV W5.9× H10mm SV W3.8× H7.6mm	W4.8×H7.8mm		PV W9.8×H14.2mm SV W8×H10mm	W3.8×H7.6mm	W8×H10mm	PV W9.8×H14.2mm SV W8×H10mm
Input	Thermocouple	K (CA), J (IC), R (PR), E (CR), T (CC), S (PR), N (NN), W (TT) <Tolerance of line resistance is max. 100Ω per a wire>							
	RTD	Pt100Ω, JIS Pt100Ω, 3 wire type <Tolerance of line resistance is max. 5Ω per a wire>							
	Analog	1-5VDC, 0-10VDC, 4-20mADC							
Output	Relay	250VAC 3A 1c							
	SSR	12VDC ±3V 30mA Max.							
	Current	4-20mADC Load 600Ω Max.							
	Transmission	—	PV : 4-20mADC Load max. 600Ω	—	PV transmission : 4-20mADC Load max. 600Ω				
	Sub	Event 1 : Relay 250VAC 1A 1a	Event 1, 2: Relay 250VAC 1A 1a	Event 1 : Relay 250VAC 1A 1a	Event1, 2 : Relay 250VAC 1A 1a				
	Commu- nication	—	PV transmission, SV set	—	—	PV transmission, SV set			
Control type	ON/OFF control P, PI, PD, PIDF, PIDS								
Display accuracy	F.S ± 0.3% or 3℃ (Higher one)								
Setting type	Front push buttons								
Hysteresis	Adjustable 1~100℃ (0.1~100.0℃) at ON/OFF control								
Alarm output	Changeable alarm output ON/OFF 1~100(0.1~100.0)℃								
Proportional band(P)	0.0 ~ 100.0%								
Integral time(I)	0 ~ 3600sec.								
Derivative time(D)	0 ~ 3600sec.								
Control time(T)	1 ~ 120sec.								
Sampling time	0.5sec.								
LBA setting time	1 ~ 999sec.								
RAMP setting time	Ramp Up, Ramp Down at 1~99min.								
Dielectric strength	2000VAC 50/60Hz for 1min.								
Vibration	0.75mm amplitude at frequency of 10 ~ 55Hz in each of X, Y, Z directions for 2 hours								
Relay life cycle	Main output	Mechanical : Min.10,000,000 times, Electrical : Min.100,000 times (250VAC 3A resistive load)							
	Sub output	Mechanical : Min.20,000,000 times, Electrical : Min.300,000 times (250VAC 1A resistive load)							
Insulation resistance	Min. 100MΩ (at 500VDC)								
Noise	Square shaped noise by noise simulator (pulse width 1μs) ± 1.2kV								
Memory retention	Approx. 10years (When using non-voltage semicondst memory type)								
Ambient temperature	-10 ~ 50℃ (at non-freezing status)								
Storage temperature	-20 ~ 60℃ (at non-freezing status)								
Ambient humidity	35 ~ 85%RH								
Weight	Approx.150g	Approx.250g	Approx.259g	Approx.136g	Approx.136g	Approx.270g	Approx.259g	Approx.270g	Approx.360g
Approval									

(A) Counter

(B) Timer

(C) Temp. controller

(D) Power controller

(E) Panel meter

(F) Tacho/ Speed/ Pulse meter

(G) Display unit

(H) Sensor controller

(I) Proximity sensor

(J) Photo electric sensor

(K) Pressure sensor

(L) Rotary encoder

(M) 5-Phase stepping motor & Driver & Controller

TZN/TZ Series

Connections

- ※RTD(Resistance Temperature Detector) : DIN Pt 100Ω (3-wire type), JIS Pt 100Ω (3-wire type)
- ※T.C(Thermocouple) : K, J, R, E, T, S, W, N
- ※In case of Analog input, please use T.C terminal and be careful about polarity.

●TZN4S

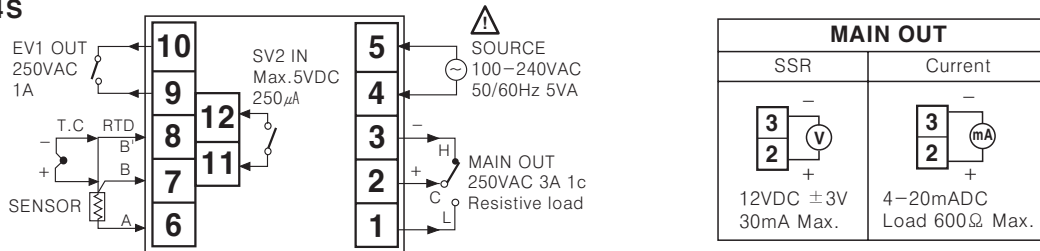

●TZN4M

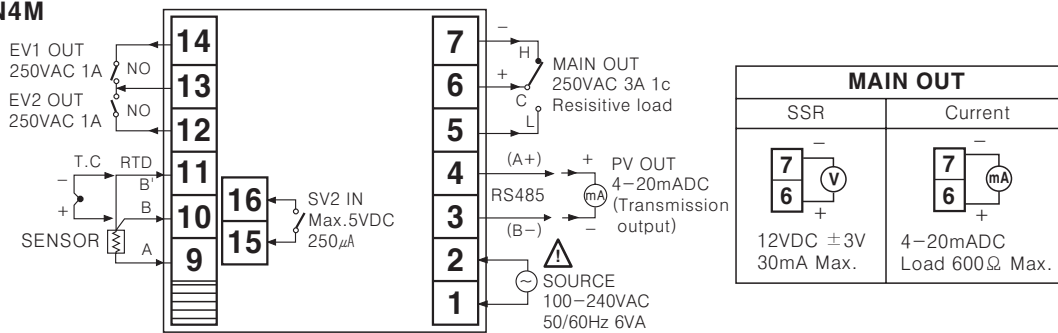

●TZ4SP

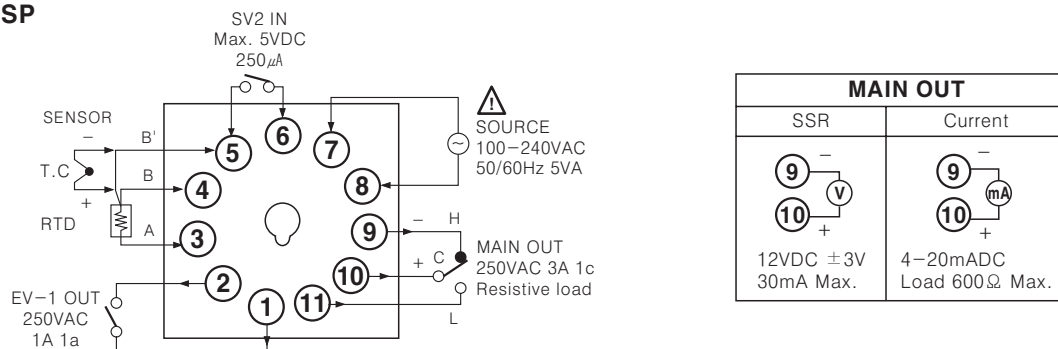

●TZ4ST

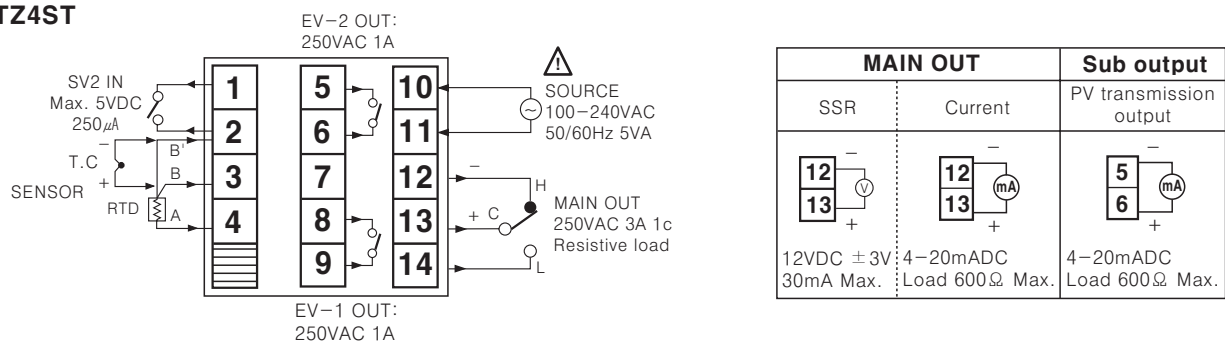

●TZ4M

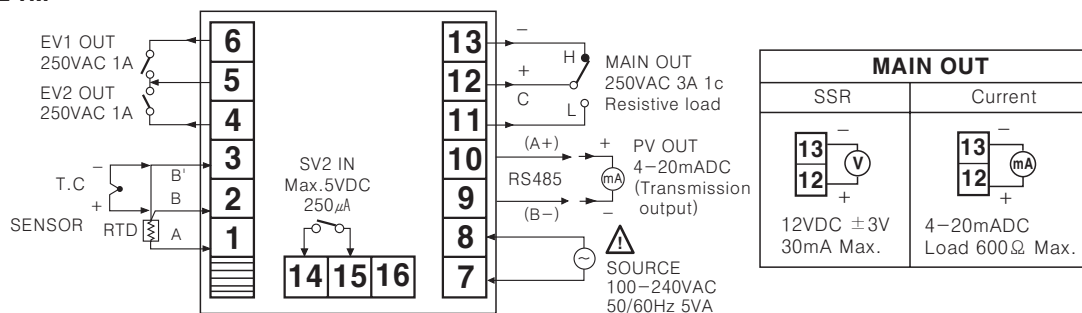

Dual PID Auto Tuning Controller

●TZ4W

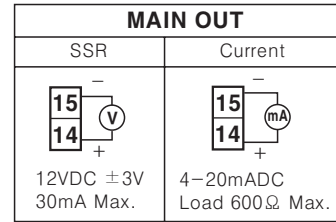
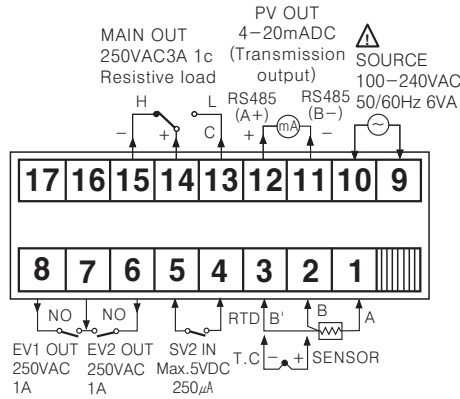

●TZ4H

●TZ4H

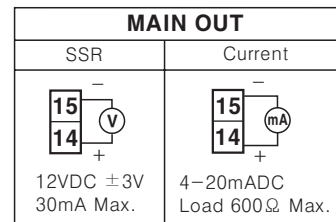
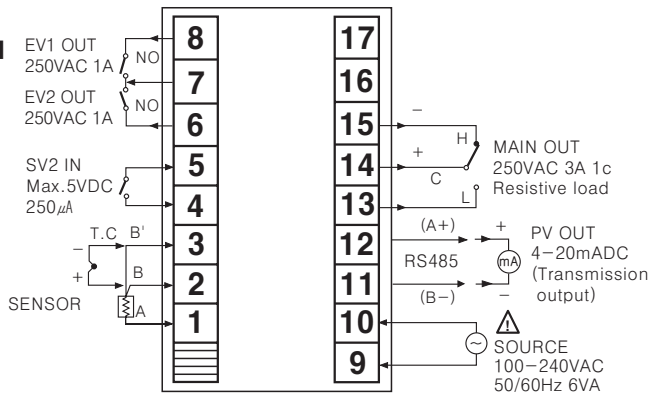

●TZ4L

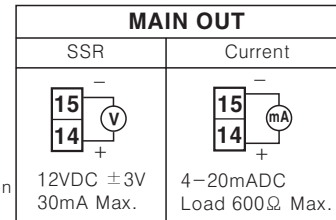
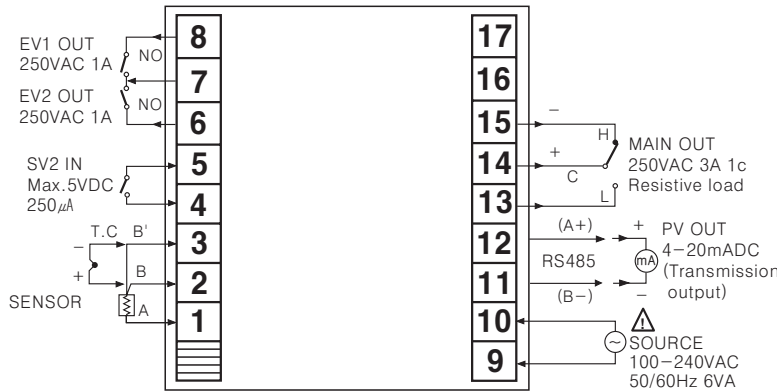

■ Dimensions

●TZ4S

●Bracket

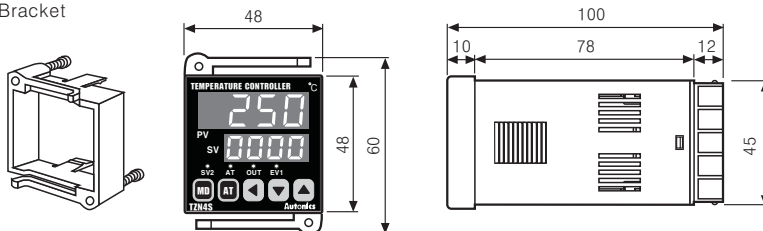

●Panel cut-out

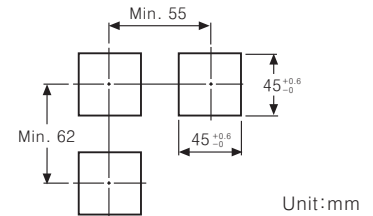

●TZ4M

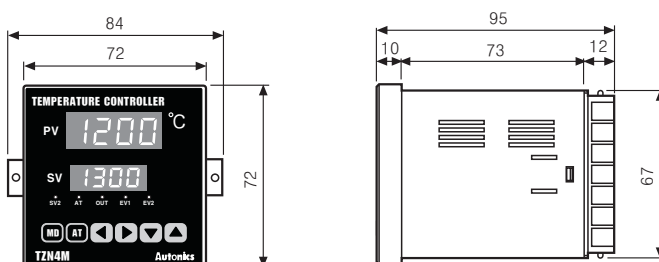

●Panel cut-out

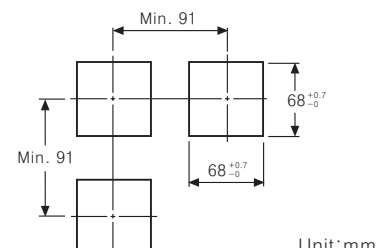

(A)
Counter

(B)
Timer

(C)
Temp.
controller

(D)
Power
controller

(E)
Panel
meter

(F)
Tacho/
Speed/
Pulse
meter

(G)
Display
unit

(H)
Sensor
controller

(I)
Proximity
sensor

(J)
Photo
electric
sensor

(K)
Pressure
sensor

(L)
Rotary
encoder

(M)
5-Phase
stepping
motor &
Driver &
Controller

TZN/TZ Series

■ Dimensions

● TZ4SP

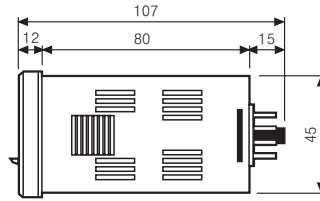
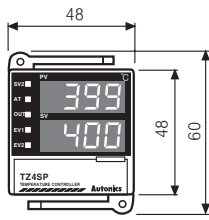

● Panel cut-out

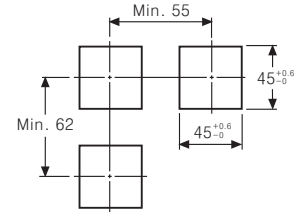

● TZ4ST

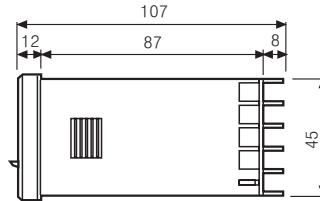
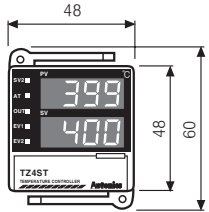

● Bracket

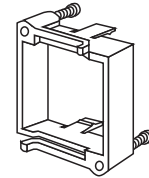

Unit:mm

※ Since TZ4SP uses same identification plate with TZ4ST, the ramp does not work even though it has a EV2 output signal ramp.

● TZ4M

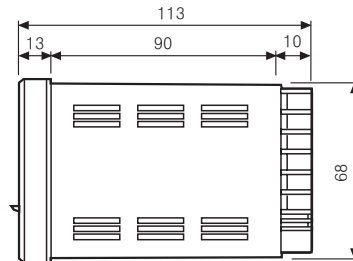
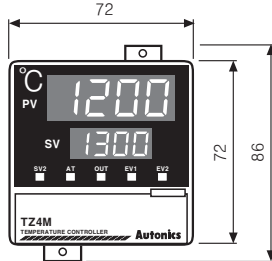

● Panel cut-out

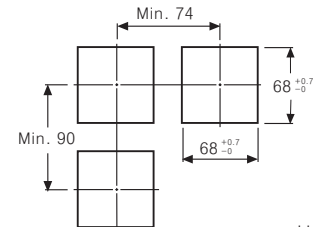

Unit:mm

● TZ4H

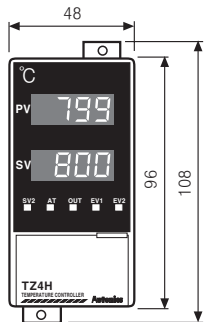

● TZN4H

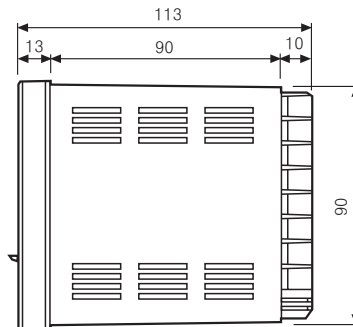
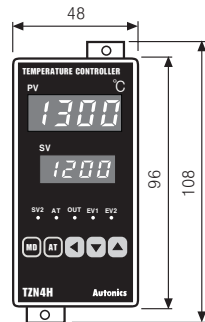

● Panel cut-out

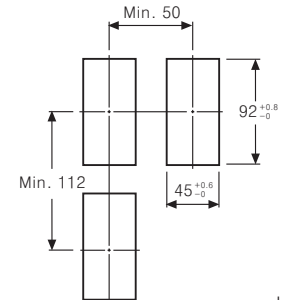

Unit:mm

● TZ4W

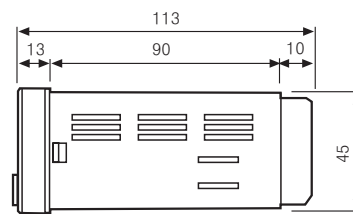
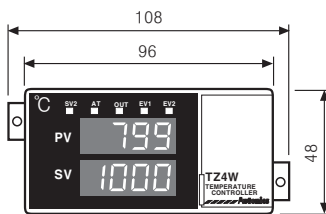

● Panel cut-out

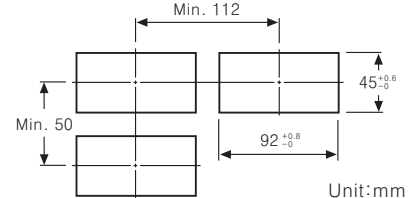

Unit:mm

● TZ4L

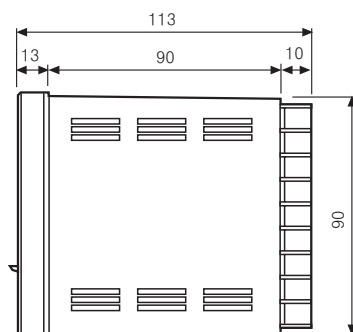
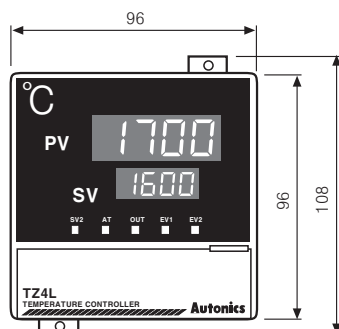

● Panel cut-out

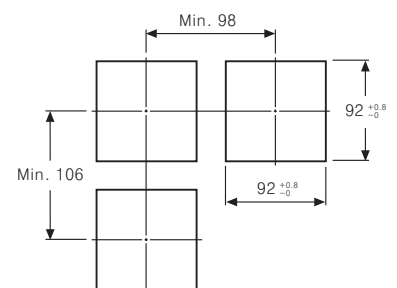

Unit:mm

Dual PID Auto Tuning Controller

Front panel identification

●TZN4S

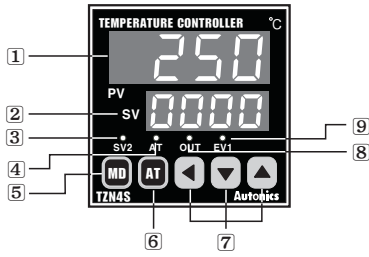

●TZN4M

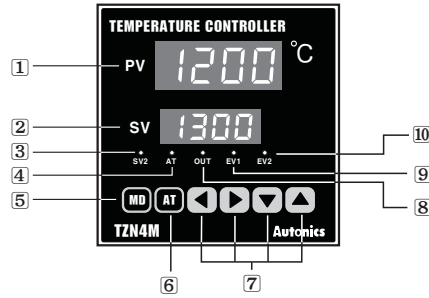

●TZ4ST/TZ4SP

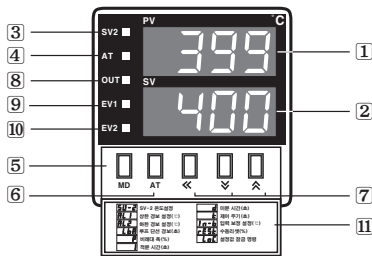

●TZ4M

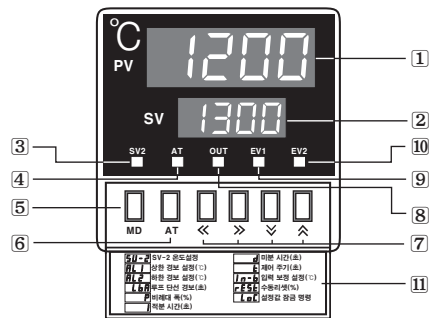

- ① : PV : Display Processing value(Red)
- ② : SV : Display Setting value(Green)
- ③ : Indicate SV2 operation
- ④ AT Key : Indicate Autotuning operation
- ⑤ MD Key : Mode key
- ⑥ AT Key : Autotuning run key
- ⑦ Setting keys
- ⑧ OUT : Indicate output
- ⑨ EV1 : Indicate EVENT 1 output
- ⑩ EV2 : Indicate EVENT 2 output
- ⑪ : Procedure of set key

※Since TZ4SP uses same identification plate with TZ4ST, the ramp does not work even though it has a EV2 output signal ramp.

※The front panel identification of TZ4W, TZ4H, and TZ4L Type is same as TZ4M.

How to change the set value

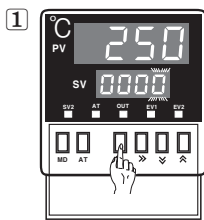

In case of changing the set value at status of RUN, push \leftarrow (\ll) key. 10^0 digit will flash at SV.

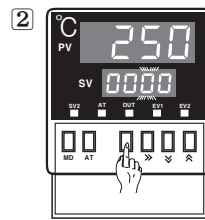

Push \leftarrow (\ll) key, and then the flicker will be shifted step by step.

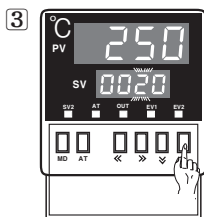
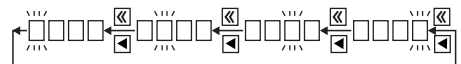

Push \downarrow (\Downarrow), \uparrow (\Uparrow) at the flicker digit, and then change the set value.

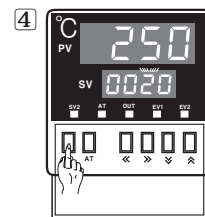

Push **MD** key when the setting is completed. It will stop flickering, then return to **RUN** mode.

※Above explanations are the example of TZ4M. In case of TZ series.

Use the Key in brackets for setting(changing).

There are no \rightarrow (\gg) Key in TZN4S, TZ4SP and TZ4ST. It is not used for setting or changing the setting value.

(A) Counter

(B) Timer

(C) Temp. controller

(D) Power controller

(E) Panel meter

(F) Tacho/Speed/Pulse meter

(G) Display unit

(H) Sensor controller

(I) Proximity sensor

(J) Photo electric sensor

(K) Pressure sensor

(L) Rotary encoder

(M) 5-Phase stepping motor & Driver & Controller

TZN/TZ Series

Flow chart for first setting group

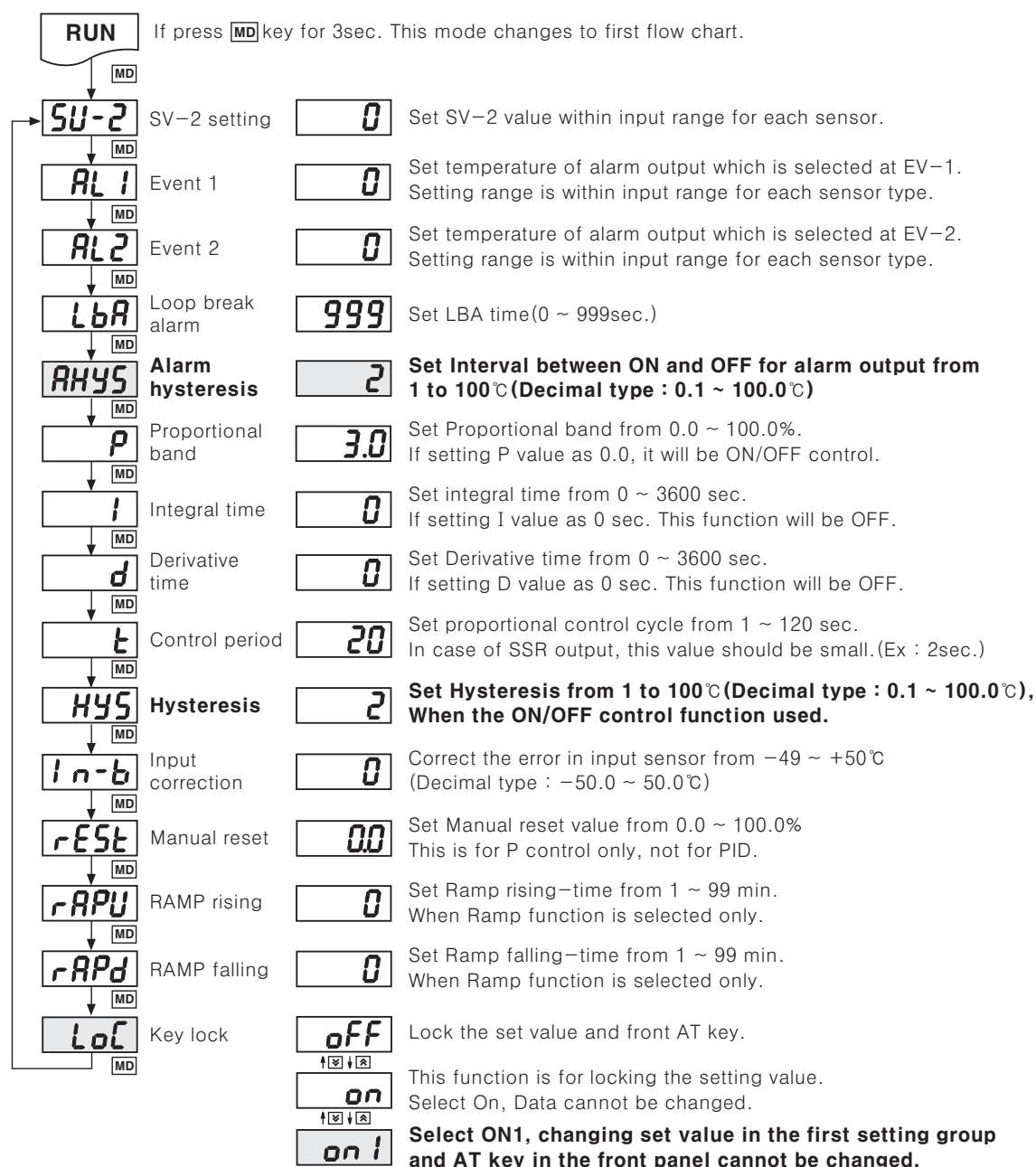

※ It will start to flicker by pressing **◀** (◀) key and the flicker will be moved by **◀** (◀) , **▶** (▶) keys then set the value by **▲** (▲) , **▼** (▼) keys. After that if pressing **MD** key the DATA will be changed then display next mode.

※ It returns to RUN status in case of pressing **MD** key for 3sec. after setting all mode to change.

※ If no key touched for 60sec., it will return to RUN mode automatically.

※ If not to set related mode in second setting group, **AL1**, **AL2**, **LbA**, **I**, **d**, **t**, **HYS**, **rAPU**, **rAPd** mode will disappear and then jump to next mode.

Factory defaults(First setting group)

Mode	Set value	Mode	Set value	Mode	Set value	Mode	Set value
SU-2	0	P	3.0	HYS	2	rAPU	10
AL1	10	I	0	In-b	0	rAPd	10
AL2	10	d	0	AHYS	2	LoC	oFF
LbA	600	t	20	rEst	0.0		

Dual PID Auto Tuning Controller

Flow chart for second setting group

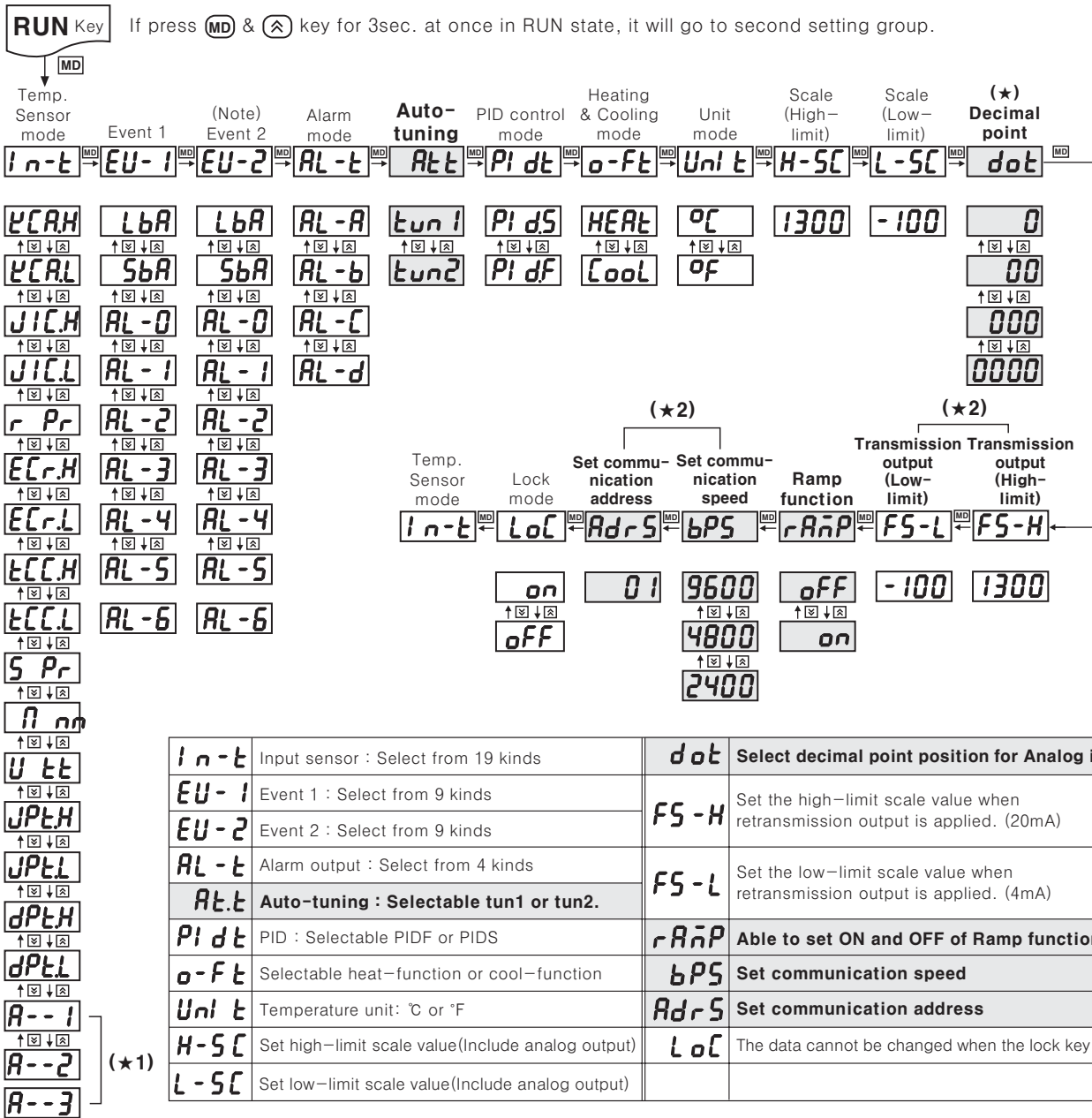

- It will start to flicker by pressing (◀) (◀◀) key then select each mode by (▲) (⊕), (▼) (⊗) keys.
- After that if press (MD) key, the DATA will be changed then display next mode.
- It returns to RUN status in case of pressing (MD) key for 3 sec. after setting all mode to change.
- If no key touched for 60sec. in each mode, it will return to RUN mode automatically.
- It not to set related mode in second setting group, AL 1, AL 2, LbA, l, d, t, HyS, rEST, rAPU, rAPd modes will disappear and then jump to next mode.
- "(★1)" might not be displayed according to the selection of input Sensor/Voltage/Current S/W.
- "(★2)" might not be displayed according to the selection of option.

Factory defaults(Second setting group)

Mode	Set value	Mode	Set value	Mode	Set value	Mode	Set value
In-t	ECr.H	AL-t	AL-A	Pi dt	Pi dS	H-SC	1300
EU-1	AL-1	At.t	tun1	o-ft	HEAt	L-SC	-100
EU-2	AL-2	rAnP	off	Uni t	°C	LoC	off







- (A) Counter
- (B) Timer
- (C) Temp. controller
- (D) Power controller
- (E) Panel meter
- (F) Tacho/Speed/Pulse meter
- (G) Display unit
- (H) Sensor controller
- (I) Proximity sensor
- (J) Photo electric sensor
- (K) Pressure sensor
- (L) Rotary encoder
- (M) 5-Phase stepping motor & Driver & Controller

TZN/TZ Series

Input range for the sensor

Input sensor		Display	Selectable temperature range °C	Selectable temperature range °F	
Thermocouple	K(CA) H	℄CAH	-100~1300°C	-148~2372°F	
	K(CA) L	℄CAL	-100.0~999.9°C	This mode cannot be used as °F	
	J(IC) H	JICH	0~800°C	32~1472°F	
	J(IC) L	JICL	0.0~800.0°C	This mode cannot be used as °F	
	R(PR)	r Pr	0~1700°C	32~3092°F	
	E(CR) H	ECr.H	0~800°C	32~1472°F	
	E(CR) L	ECr.L	0.0~800.0°C	This mode cannot be used as °F	
	T(CC) H	tCCH	-200~400°C	-328~752°F	
	T(CC) L	tCCL	-199.9~400.0°C	This mode cannot be used as °F	
	S(PR)	S Pr	0~1700°C	32~3092°F	
	N(NN)	n nn	0~1300°C	32~2372°F	
	W(TT)	U tt	0~2300°C	32~4172°F	
RTD	JIS standard	JPt H	JPt.H	0~500°C	32~932°F
		JPt L	JPt.L	-199.9~199.9°C	-199.9~391.8°F
	DIN standard	DPt H	dPt.H	0~500°C	32~932°F
		DPt L	dPt.L	-199.9~199.9°C	-199.9~391.8°F
Analog input	0~10VDC	A - - 1	-1999~9999°C	-1999~9999°F	
	1~5VDC	A - - 2	-1999~9999°C	-1999~9999°F	
	4~20mADC	A - - 3	-1999~9999°C	-1999~9999°F	

Selection switch for Input sensor/Voltage/Current

A) In case of thermocouple input <K(CA), J(IC), R(PR), E(CR), T(CC), S(PR), N(NN), W(TT)> In case of RTD input <DPtL, DPtH, JPtL, JPtH >				
S/W1			S/W2	
S/W1:1	1 1	mA V	S/W2:V	
B) In case of voltage input <1~5VDC, 0~10VDC >				
S/W1			S/W2	
S/W1:2	2 2	mA V	S/W2:V	
C) In case of current input <4~20mADC >				
S/W1			S/W2	
S/W1:2	2 2	mA V	S/W2:mA	

※Input sensor/Voltage/Current conversion switch factory specification : Temperature sensor input

※Please select B) or C) according to input specification when it is voltage or current.

Dual PID Auto Tuning Controller

■ Sub output(EVENT) function

This unit has output for control and sub(alarm) output. Sub output is optional. (This alarm output is relay output and operates regardless to output for control.) Alarm output operates when the temperature of target is getting higher or lower than setting value.

- 1 alarm mode can be selected among 7 kinds of alarm mode at **EV-1 (EV-2)** in the second setting group.
- Since **EV-1** and **EV-2** operate separately, both **EV-1** and **EV-2** cannot be used as a high or low 2nd alarm operation.
- When selecting **LbA** or **SbA** function in **EV-1(EV-2)** of **EV-1**, alarm cannot be operated.
- Please note below "Operation chart for alarm output" & "Option of alarm output" regard to detailed operation and optional operation.

■ Operation chart for alarm output

AL-0	—————	No alarm output
AL-1	<p>※When set 10°C in AL 1(AL 2) as deviation temperature.</p>	<p>■ Deviation High-limit alarm</p> <p>If deviation between PV and SV is occurring higher than deviation temperature setting value, the output will be ON. The deviation temperature is set in AL-1 or AL-2 of first setting group.</p>
AL-2	<p>※When set 10°C in AL 1(AL 2) as deviation temperature.</p>	<p>■ Deviation Low-limit alarm</p> <p>If deviation between PV and SV is occurring lower than deviation temperature setting value, the output will be ON. The deviation temperature is set in AL-1 or AL-2 of first setting group.</p>
AL-3	<p>※When set 10°C in AL 1(AL 2) as deviation temperature.</p>	<p>■ Deviation High/Low-limit alarm</p> <p>If deviation between PV and SV is higher or lower than deviation temperature setting value, the output will be ON. The deviation temperature is set in AL-1 or AL-2 of first setting group.</p>
AL-4	<p>※When set 10°C in AL 1(AL 2) as deviation temperature.</p>	<p>■ Deviation High/Low-limit reverse alarm</p> <p>If deviation between PV and SV is higher or lower than deviation temperature setting value, the output will be OFF. The deviation temperature is set in AL-1 or AL-2 of first setting group.</p>
AL-5	<p>※When set 110°C in AL 1(AL 2) as alarm temperature.</p>	<p>■ The absolute value High-limit alarm</p> <p>If PV is equal or higher than alarm temperature setting value, the output will be ON. The deviation temperature is set in AL-1 or AL-2 of first setting group.</p>
AL-6	<p>※When set 90°C in AL 1(AL 2) as alarm temperature.</p>	<p>■ The absolute value Low-limit alarm</p> <p>If PV is equal or lower than alarm temperature setting value, the output will be ON. The alarm temperature is set in AL-1 or AL-2 of first setting group.</p>

※ "b" is interval between ON and OFF the setting range is 1 ~ 100°C (0.1 ~ 100.0°C) and can be set at "RHYS" made in first setting group.

■ Alarm setting [AL-t]

Symbol	Operation name	Function
AL-A	General alarm	No optional alarm output.
AL-b	Latch function	When alarm output turns on once, the output will be ON continuously.
AL-C	Standby sequency function	It doesn't output at first operation. (When it reaches to first object value)
AL-d	Latch & Standby sequency function	It operates latch & Standby sequence function together.

(A)
Counter

(B)
Timer

(C)
Temp.
controller

(D)
Power
controller

(E)
Panel
meter

(F)
Tacho/
Speed/
Pulse
meter

(G)
Display
unit

(H)
Sensor
controller

(I)
Proximity
sensor

(J)
Photo
electric
sensor

(K)
Pressure
sensor

(L)
Rotary
encoder

(M)
5-Phase
stepping
motor &
Driver &
Controller

TZN/TZ Series

■ Function

◎ Autotuning operation function

PID Autotuning function automatically measures the thermal characteristics and response of the control system and then executes its value under high response & stability after calculating the time constant of PID required to control optimum temperature.

- Execute the Autotuning function at initial time after connecting the controller & the sensor.
- Execution of Autotuning is started when pressing AT key for 3sec. or more.
- When the Autotuning is started, AT lamp will flicker, and when the lamp is OFF, this operation will stop.
- While the Autotuning function is executing, it is stopped by pressing AT key for 5sec. or more.
- When the power turns off or the stop signal is applied while Autotuning function is executing, time constant of PID is not changed and it remembers the value before power turns off.
- Time constant of PID selected by Autotuning function can be changed in first setting mode.

- **It has two kinds of Autotuning mode. Autotuning operation is executed at setting value(SV) in Tun1 mode which is factory default. Autotuning operation is executed at 70% of setting value(SV). Mode change is available in second setting group.**

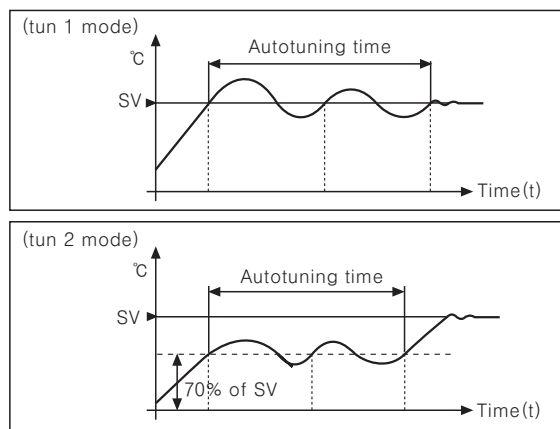

- Execute the Autotuning function again periodically, because the thermal characteristics for the control object can be changed when the controller is used continuously for a long time.

◎ Sub output(Event) function

Sub output can execute as main control output and sub function as well. There is one sub output in this unit.

- This sub output is relay "A" contact output.
- 1 mode can be selected among 7 kinds of alarm mode or LBA operated when the heater line is cut, SBA operated when the sensor line is cut.
- The Sub output can be latched ON or automatically reset depending on the alarm option mode selected.
- When the sensor line or the heater line is cut, SBA or LBA output turns on. This "Output on" status must be reset by turning the power off.

◎ Sensor Break Alarm(SBA) function

This function causes the sub output to turn on when the sensor line is cut or open.

It can easily check that the sensor line is cut or not by operating a buzzer by the relay contact.

- Set SBA mode at Event1 or Event2 mode in second setting group.

◎ Loop Break Alarm(LBA) function

LBA function is to diagnose an abnormal temperature of the control system. If the temperature of the control system is not changed within $\pm 2^{\circ}\text{C}$ during setting time of LBA, the LBA output will be ON.

Ex) When setting value(SV) is 300°C , processing value(PV) is 50°C , this unit controls 100%.

In this time if there is no change of system temperature, it recognizes Heater is cut off then LBA output will be ON.

- LBA output can be selected at EV1 of the second setting group.
- If LBA output is not selected at event output, it will not be displayed.
- Setting range of LBA output is 1 to 999sec.
- If thermal response of the control system is slow, LBA value should be set to a high value.
- LBA output operates when the manipulated value of the controller is 0% and 100%.
- In case the LBA output is ON, please check the following:
 - ① Short-circuit or cutting of the temp. sensor.
 - ② Abnormal condition of the equipment (Conductor, sub-relay, etc.)
 - ③ Abnormal condition of the load (Heater, cooler)
 - ④ Wrong-wiring or cutting of the other cables.
- The output of LBA function is EV1 and EV2 output.
- If you use LBA function, SBA and alarm operation function cannot be used.
- Once SBA is ON due to broken sensor, it will not reset, although sensor is connected.
In this case, turn off the power then turn on again.

◎ Error display

If error is occurred while the controller is operating, it will be displayed as follow.

- "LLLL" is flickering when measured input temperature is lower than input range of the sensor.
- "HHHH" is flickering when measured input temperature is higher than input range of the sensor.
- "oPEn" is flickering when the input sensor is not connected or its wire is cut.

Dual PID Auto Tuning Controller

◎ON/OFF control

ON/OFF control is called two position control because the output turns on when PV falls lower than SV and the output turns off when PV is higher than SV. This control method is not only for controlling temperature, but also it is basic control method for sequence control.

- If you set P value as "0.0" in first setting group, ON/OFF control will operate.
- There is a programmable temperature difference between ON and OFF in ON/OFF control, if difference is too small, then hunting(chattering) can occur. Temperature difference can be set in HyS position of first setting group. Setting range is 1 to 100(or 0.1 to 100.0).
- HyS mode is displayed when P value is "0", but HyS will not be displayed, and then jump if P value is not "0".
- This ON/OFF control should not be applied when equipment(Cooling compressor) to be controlled can be damaged by frequent ON and OFF.
- Even if ON/OFF control is stable status, the hunting can be occurred by setting value in HyS or capacity of the heater or response characteristic of the equipment to be controlled or installing position of the sensor. Please consider above points to minimize the hunting when designing the system.

◎Manual reset function

Proportional control has deviation because rising time is not same as falling time, even if the unit operates normally. Manual reset function is used at proportional control mode only.

- If set **r-ES**t function in first setting group, the manual reset will run.
- When PV and SV is equal, Reset value is 50% and when control is stable, if the temperature is lower than SV, reset value should be higher and on the other hand, reset value should be smaller.
- r-ES**t setting method according to result of control.

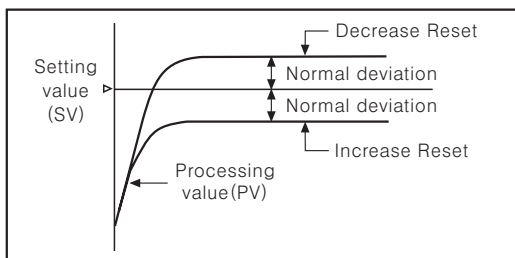

◎Dual PID control function

When controlling temperature, two types of control characteristic are available as below. One is when you need to minimize the time which PV reaches to SV as like(Fig. 1). The other is when you need to minimize overshoot even though the reaching time (PV to SV) is slow(Fig. 1).

- There are high-speed response type and low-speed response type built in this unit. Therefore user can select each function according to their application.
- You can select dual PID control function in second setting group. It is selectable PIDF or PIDS in PIDT display.
- PIDF(High-speed response type)
This mode is applied to machines or systems which require high-speed response.
Ex)Machines which must be applied preliminary heat before it operates
*Injection machine, an electric furnace, etc.

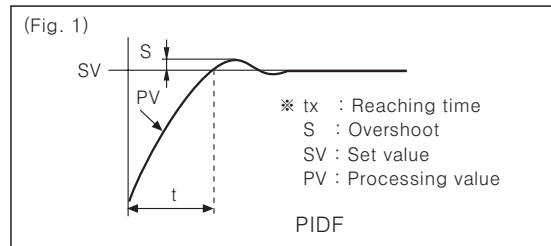

- PIDS(Low-speed response type)
This mode is applied at the machine which requires little overshoot.
Ex)Because a fire can occur by overshoot of the temperature.
*Plating machine to control temperature, oiling system to control temperature of oil, etc.

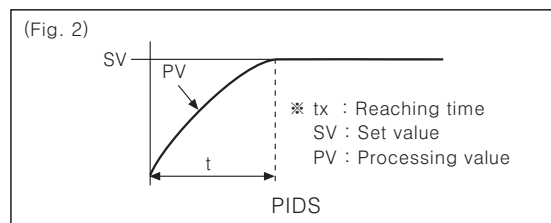

*Factory default setting is PIDF in TZ/TZN series.
According to control system, please select mode.

◎RS485 communication function

It is used on the purpose that transmitting PV to an external equipment, setting SV at the external equipment.

- It can be set at bps, Adrs in second setting group
- bps setting : 2400, 4800, 9600bps
(Start bit1, Stop bit1, Non parity)
- Adrs setting : 1 ~ 99
- Compatible PLC : LG, Mitsubishi, CIMON etc.
- If the external equipment is a PC(Personal Computer) using Converter(SCM-38I) sold separately.

◎Decimal point(Dot) setting function

Decimal point is displayed as "dot" in second setting group when the input is analog only. (0-10VDC, 1-5VDC, DC4-20mA)

(A)	Counter
(B)	Timer
(C)	Temp. controller
(D)	Power controller
(E)	Panel meter
(F)	Tacho/Speed/Pulse meter
(G)	Display unit
(H)	Sensor controller
(I)	Proximity sensor
(J)	Photo electric sensor
(K)	Pressure sensor
(L)	Rotary encoder
(M)	5-Phase stepping motor & Driver & Controller

TZN/TZ Series

◎Cool/Heat function

Generally there are two ways to control temperature, one(Heat-function) is to heat when PV is getting down(Heater). The other(Cool-function) is to cool when PV is getting high(Refrigerator).

These functions are operating oppositely when it is ON/OFF control or proportional control.

But in this case PID time constant will be different due to PID time constant will be decided according to control system when it is PID control.

- Cool-function and heat-function can be set at "Second setting group".
- Cool-function and heat-function must be set correctly according to the application, if set as opposite function, it may cause a fire.
(If set cool-function at heater, even if temperature is getting high, it will be maintained ON and it may cause a fire.)
- Avoid changing heat-function to cool-function or cool-function to heat-function on the unit is operating.
- It is impossible to operate both function at once in this unit. Therefore, only one function should be selected only.
- Factory default setting is heat-function.

◎SV-2 function

If using SV-2 function, it changes the temperature of control system to the second setting value by external relay contact signal. It can change the setting value as sequentially by relay contact without key operation.

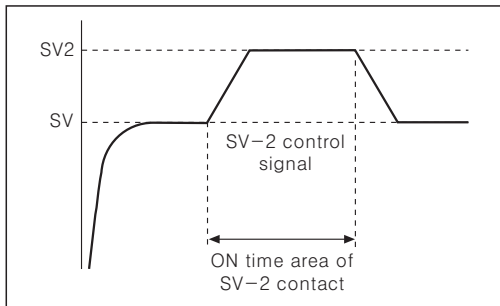

- It can set SV-2 at required time and particular area as like the above chart.
- SV-2 is in first setting group.
- Application :

The control system, which has to maintain constant temperature such as oven application. If you open the door, temperature will go down.

In this case if you set the second setting value higher than setting value, temperature will rise fast. Therefore, after installing a micro-switch in order to detect the door Open/Close and connect it to SV-2(the second setting value should be higher than SV) then it controls temperature of oven efficiently.

◎Ramp function

Ramp function is to delay the rising time or falling time of temperature. If you change setting value at stable state of control, it forces to rise or fall the temperature of control system during setting time at rAPU, rAPd in first setting group.

If rAMP is not ON in second setting group, rAPd, rAPd will not be displayed in first setting group.

- Set rAMP is ON in second setting group for using Ramp function.
- Ramp function will be operating when changing the set value at stable control status or supply the power again after the power was removed.

※rAPU function(Delay of rising time)

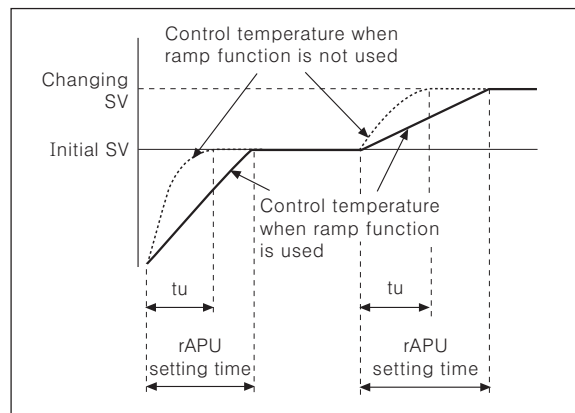

It makes delay rising temperature when change the set value at stable control status or delay the initial rising temperature as like above picture.

※rAPd function(Delay of falling time)

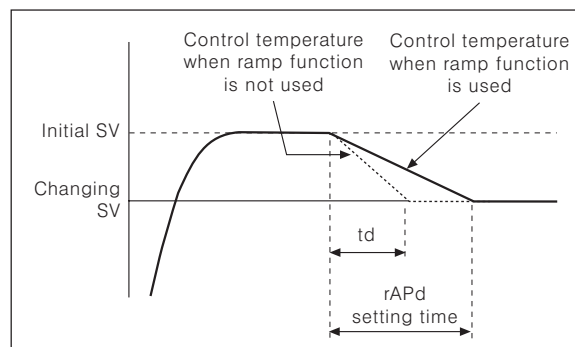

It controls falling temperature as like above: (rAPd time cannot be shorter than falling time of not being Ramp function operated.)

Ramp function will not be seen in the first setting group if not choose the function selection switch (RMP).

Dual PID Auto Tuning Controller

◎Input correction(In-b) function

Input revise is to correct deviation occurred from temperature sensor such as thermocouples, RTD, Analogue sensor etc.

If you check the deviation of every thermo sensor precisely, it can measure temperature accurately.

- Input revise can be set at "In-b" mode in first setting group.
- Use this mode after measuring deviation occurred from temperature sensor exactly.
Because if measured deviation value is not corrected, displayed temperature may be too high or too low.
- Setting range of input revise is $-49 \sim +50^{\circ}\text{C}$ ($-49.0 \sim +50.0^{\circ}\text{C}$)
- When you set the Input revise value, you may need to record it, because it will be useful when performing maintenance.

◎Analogue input(A-1, A-2, A-3 mode)

- In case of measuring or controlling humidity & pressure, flux, etc, it uses the proper converter which is converting the measuring value to 4-20mADC or 1-5VDC or 0-10VDC.

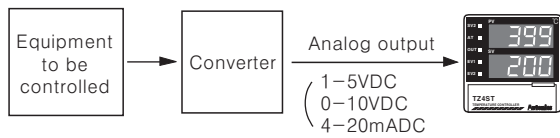

- This unit has the mode for the converter built-in. Please select A--1 (0-10VDC) or A--2 (1-5VDC) or A--3 (4-20mADC) in selection mode of input in second setting group.
- Set the input value by H-SC and L-SC mode.
- Please connect analog output of converter to terminal No.2, 3 of temperature controller. And be sure to observe correct polarity. (But TZ4SP is terminal No. 4, 5)
- The other operation function after doing that is same as controlling the temperature.

●Ex)

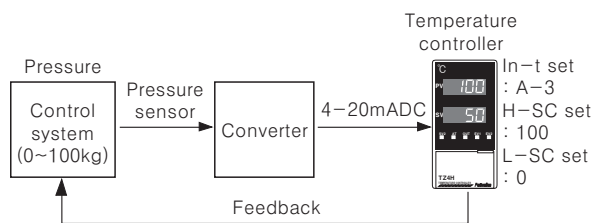

◎Output connections

- Application of relay output type

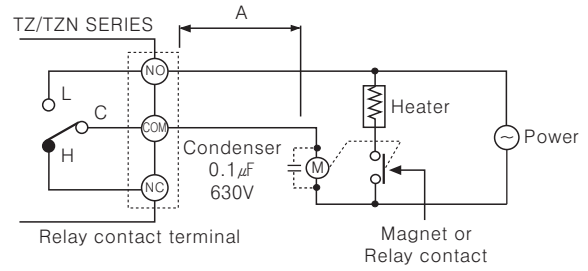

Keep power relay as far away as possible from TZ/TZN series. If wires length of A is short, electromotive force occurred from a coil of magnet switch & power relay may flow in power line of the unit, it may cause malfunction. If wires length of B is short, please connect a mylar condenser 104 (630V) across coil of the power relay "M" to protect electromotive force.

- Application of SSR output type

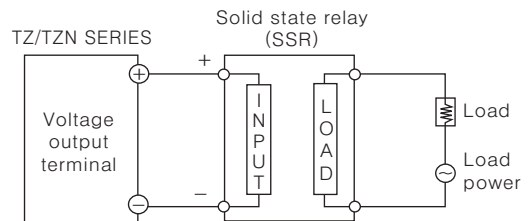

- ※SSR should be selected by the capacity of load, otherwise, it may short-circuit and result in a fire.
- ※Indirect heated should be used with SSR for efficient working.

- Application of current output(4-20mADC)

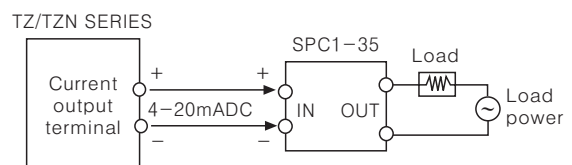

- ※It is important to select SCR unit after checking the capacity of the load.
- ※If the capacity is exceeded, it may cause a fire.

- Application of transmission output(4-20mADC)

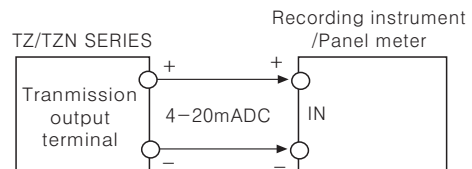

- Application of communication output(RS485)

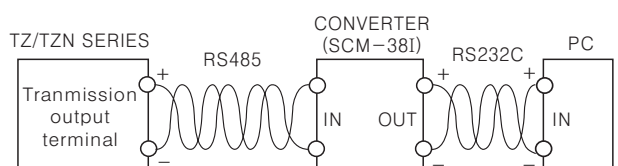

(A) Counter

(B) Timer

(C) Temp. controller

(D) Power controller

(E) Panel meter

(F) Tacho/Speed/Pulse meter

(G) Display unit

(H) Sensor controller

(I) Proximity sensor

(J) Photo electric sensor

(K) Pressure sensor

(L) Rotary encoder

(M) 5-Phase stepping motor & Driver & Controller

TZN/TZ Series

Communication control

System ordering

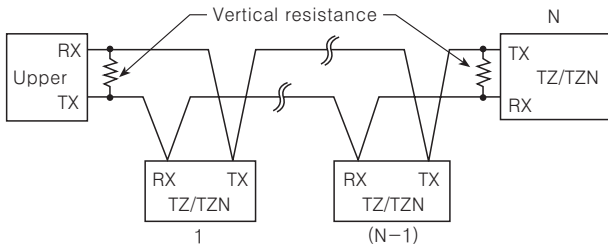

Communication control ordering

1. The communication control ordering of TZ/TZN series is exclusive protocol
2. After 4sec. being supplied the power in to upper system, then able to start communicating.
3. Initial communication will be started by upper system. When Command signal comes out from upper system then TZ/TZN series will respond.

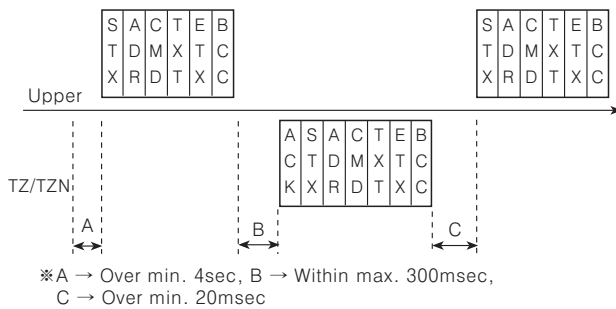

Communication Command and Block

Format of Command and Response

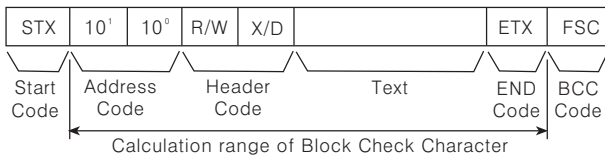

- ①Start code :
It indicates the first of BLOCK STX → [02H], in case of response, ACK will be added.
- ②Address code :
This code is upper system can discern TZ/TZN series and able to set within range of 01 to 99. (BCD ASCII)
- ③Header code :
It indicates command as 2 alphabets as below.
RX (Read request) → R [52H], X [58H]
RD (Read response) → R [52H], D [44H]
WX (Write request) → W [57H], X [58H]
(Reservation at upper vision of TZ/TZN)
WD (Write response) → W [57H], D [44H]
(Reservation at upper vision of TZ/TZN)
- ④Text : It indicates the detail contents of Command/Response. (See command)
- ⑤END code :
It indicates the end of BLOCK. ETX → [03H]
- ⑥BCC : It indicates XOR operating value from the first to ETX of the protocol as abbreviation of TZ/TZN.

Communication Command

Read[RX] of measurement/setting value : Address 01, Command RX

1. Command (Upper)

①Command

STX	0	1	R	X	P	0	ETX	FSC
Start	Address		Command head		P:Processing value S:Setting value		End	BCC

- ②Application : Address (01), Header code (RX), Current value (P)

STX	0	1	R	X	P	0	ETX	FSC
02H	30H	31H	52H	58H	50H	30H	03H	BCC

Write[WX] of Processing value : Address 01, Command WX

1. Command (Upper)

①Command

STX	0	1	W	X	S	0	Symbol	10 ³	10 ²	10 ¹	10 ⁰	ETX	FSC
Start	Address		Command head		S:Setting value		Space/-	10 ³	10 ²	10 ¹	10 ⁰	End	BCC

- ②Application : Address (01), Head Code (WX) setting value (S) +123

STX	0	1	W	X	S	0	Symbol	10 ³	10 ²	10 ¹	10 ⁰	ETX	FSC
02H	03H	31H	57H	58H	53H	30H	0	1	2	3	03H	BCC	

Response

Read of processing/Setting value

1. In case of receiving normal processing value :
The data is transmitted adding ACK [60H].
(In case processing value is +123.4)

A C T X	S T X	0	1	R	D	P	0	Symbol	10 ³	10 ²	10 ¹	10 ⁰	Decimal point	E T X	F S C
---------	-------	---	---	---	---	---	---	--------	-----------------	-----------------	-----------------	-----------------	---------------	-------	-------

A C T X	S T X	0	1	R	D	P	0	Space	0	1	2	3	1	E T X	B C C
---------	-------	---	---	---	---	---	---	-------	---	---	---	---	---	-------	-------

06H	02H	30H	31H	52H	44H	50H	30H	20H	30H	31H	32H	33H	31H	03H	B C C
-----	-----	-----	-----	-----	-----	-----	-----	-----	-----	-----	-----	-----	-----	-----	-------

2. In case processing value is -100

A C T X	S T X	0	1	R	D	P	0	-	0	1	0	0	0	E T X	B C C
---------	-------	---	---	---	---	---	---	---	---	---	---	---	---	-------	-------

06H	02H	30H	31H	52H	44H	50H	30H	2DH	30H	31H	30H	30H	30H	03H	B C C
-----	-----	-----	-----	-----	-----	-----	-----	-----	-----	-----	-----	-----	-----	-----	-------

Write of setting value

- (In case setting value is -100)

A C T X	S T X	0	1	W	D	S	0	Symbol	10 ³	10 ²	10 ¹	10 ⁰	E T X	F S C
---------	-------	---	---	---	---	---	---	--------	-----------------	-----------------	-----------------	-----------------	-------	-------

A C T X	S T X	0	1	W	D	S	0	-	0	1	0	0	E T X	B C C
---------	-------	---	---	---	---	---	---	---	---	---	---	---	-------	-------

06H	02H	30H	31H	57H	44H	53H	30H	2DH	30H	31H	30H	30H	30H	03H	B C C
-----	-----	-----	-----	-----	-----	-----	-----	-----	-----	-----	-----	-----	-----	-----	-------

- Others : In case of no response of ACK
 - ①When the address is not the same after receiving STX.
 - ②When receiving buffer overflow is occurred.
 - ③When the baud rate or others communication setting value are not the same.
- When there are no ACK response
 - ①Check the status of lines
 - ②Check the communication condition (Setting value)
 - ③When assuming the problem is due to noise, try to operate communication 3 times more until recovery
 - ④When occurred communication failure frequently, please adjust the communicating speed.

◎Simple "error" diagnosis

- When it displays "Open" during operation.
This is a warning that external sensor is cut off. Please turn off power and check the state of sensor. If sensor is not cut off, disconnect sensor line from terminal block and +, - together. When you turn on power it can check room temperature. If this unit cannot indicate room temperature, this unit itself is faulty. Please remove this unit from equipment and service or replace.
[When input mode is sensor input modr (thermo-couple) only, it can indicate room temperature.]
- In case of not operating the output (the heater).
Please check operation of the out lamp located in front panel of the unit.
If lamp does not operate, please check the parameter of all programmed mode.
If lamp is operating, please check the output (relay, operating voltage for SSR, current output) after separating output line from the unit.
- In case of indicating "Err0" in display
This Error message is indicated in case of damaging inner chip program data by outer strong noise. In this case, please send the unit to our after service center after removing the unit from system. Noise protection is designed in this unit, but it does not stand up strong noise continuously. If bigger noise than specified (Max. 2kV) flows in the unit, it can be damaged.

■Caution for using

- Please use the terminal (M3.5, Max. 7.2mm) when connecting the AC power source.
- "△" mark indicated on the diagram of this unit means caution—refer to accompanying documents.
- In case of cleaning the unit, please keep as following Cautions:
 - ①Clean dust with a dry tissue.
 - ②Be sure to use alcohol to clean the unit, do not use acid, chromic acid, solvent, etc.
 - ③Be sure to clean the unit after turning off the power and then turn on the power after passing 30minute after cleaning.
- If this unit is used in a manner not to be specified by the manufacture, it can be injury to a person or damage to property.
- Be sure that metal dust and wire-dregs do not flow in the unit, because of malfunction damage of the unit or the cause of a fir.
- Service life for the relay of the unit is indicated in this manual, life cycle is different according to the load capacity and switching times, therefore please use the unit after checking the load capacity and switching times.
- Connect wires correctly after checking polarity of terminals.
- Do not use this unit as following place
 - ①A place where dust, corrosiveness gas, oil, moisture are occurred.
 - ②A place where there are high humidity or freezing place.
 - ③A place where sunshine, radiant heat is occurred.
 - ④A place where vibration, shock is occurred.
- If the equipment is used in a manner not specified by the manufacture the protection provided by the equipment may be impaired.
- Please install power switch or circuit-breaker in order to cut power supply off.
- A switch or circuit-breaker meeting the relevant requirements of IEC947-1 and IEC947-3 shall be included in equipment when the temperature controller.
- The switch or circuit-breaker should be installed near by users.
- Do not use this product as Volt-meter or Ampere-meter, this is a temperature controller.
- Installation environment
 - ①It shall be used indoor
 - ②Altitude Max. 2000m
 - ③Pollution Degree 2
 - ④Installation Category II.
- If you want to change the input sensor, reset switches (SW1, SW2) according to each input specification after power off. Turn on power and then set sensor mode by front keys at second flow chart. This SSR and current of this controller are insulated from internal power.
- Do not connect power line to sensor connecting part. The inner circuit may be damaged.

※It may cause malfunction if above instructions are not followed.

(A)	Counter
(B)	Timer
(C)	Temp. controller
(D)	Power controller
(E)	Panel meter
(F)	Tacho/Speed/Pulse meter
(G)	Display unit
(H)	Sensor controller
(I)	Proximity sensor
(J)	Photo electric sensor
(K)	Pressure sensor
(L)	Rotary encoder
(M)	5-Phase stepping motor & Driver & Controller